

Перв. примен.

Справ. №

Подп. и дата

Инд. № дубл.

Взам. инд. №

Подп. и дата

Инд. № подл.

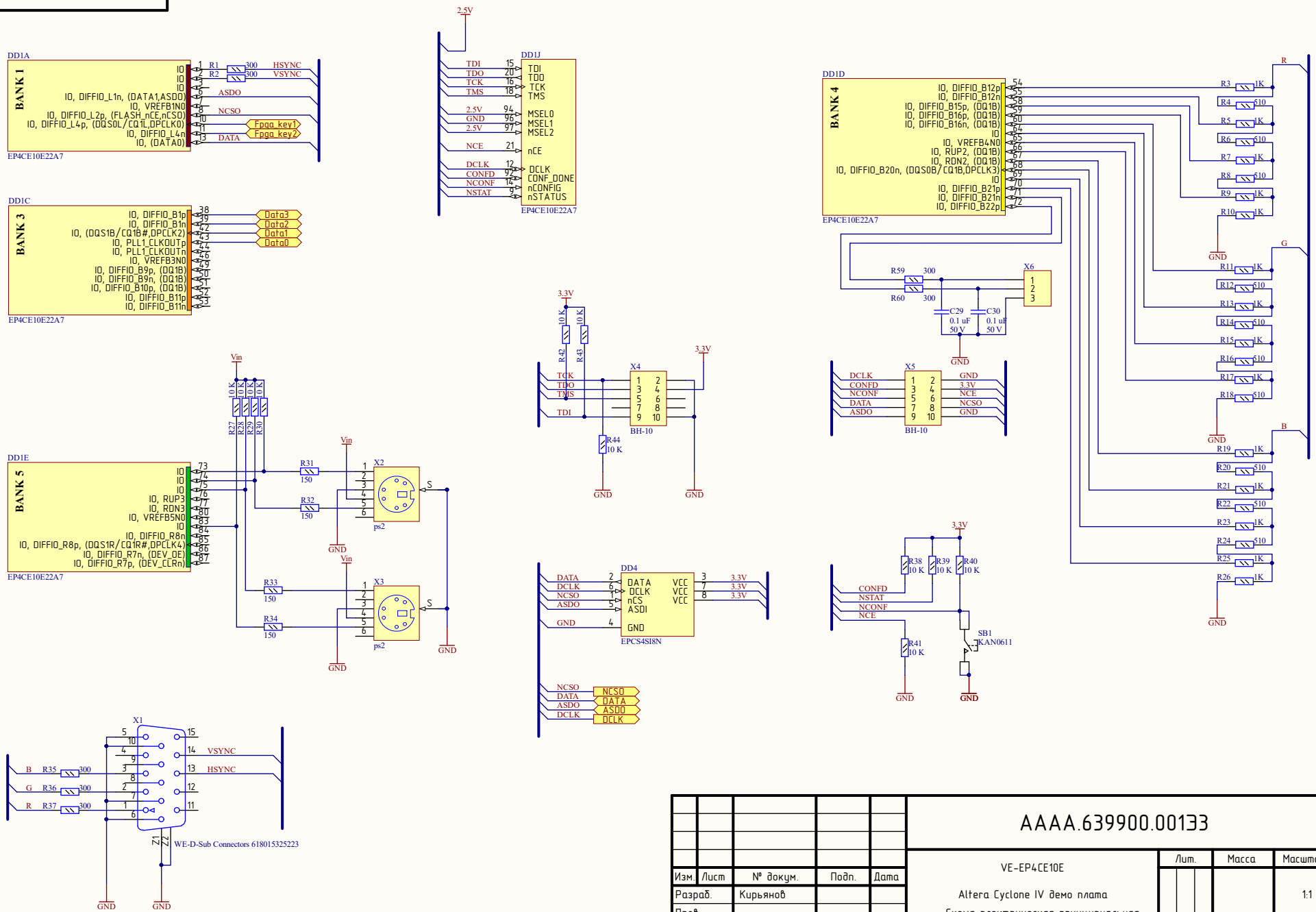

VE-EP4CE10E					Лист	Масса	Масштаб
Изм	Лист	№ докум.	Подп.	Дата	1:1		
Разраб.		Кирьянов			3		
Проб.		*			3		
Т.контр.		*			3		
Н.контр.		*			3		
Учб.		*			3		
Altera Cyclone IV демо плата					Visual electronics		
Схема электрическая принципиальная					Visual electronics		

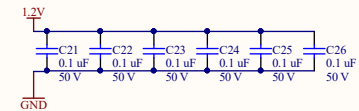
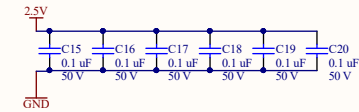
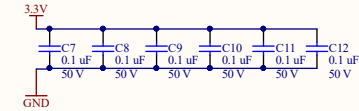
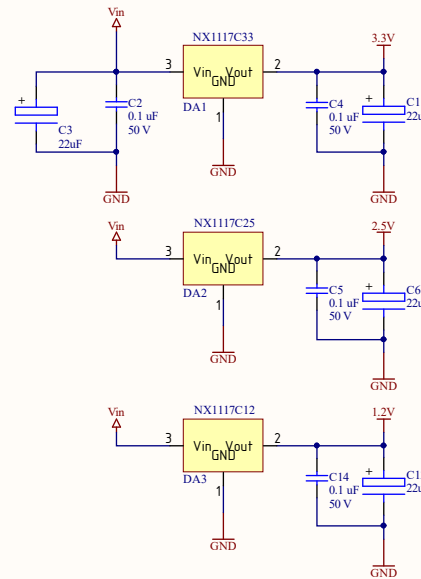
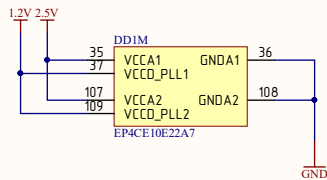
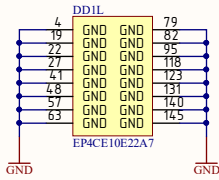
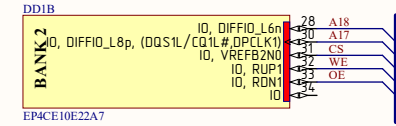
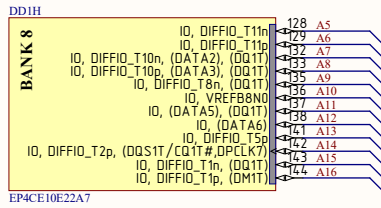
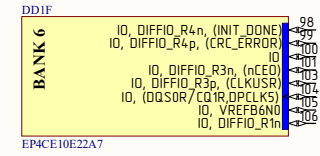
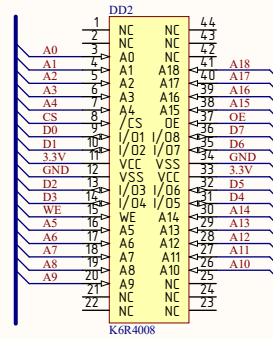
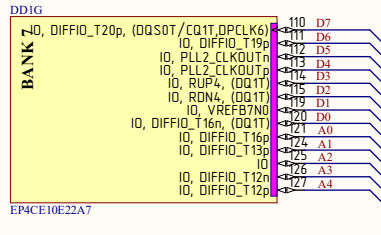

Инд. № докл.	Подп. и дата
Инд. № докл.	Инд. № докл.
Инд. № докл.	Инд. № докл.
Инд. № докл.	Инд. № докл.
Инд. № докл.	Инд. № докл.

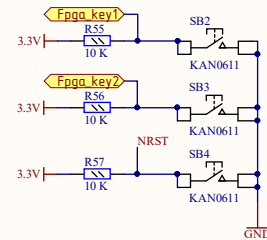
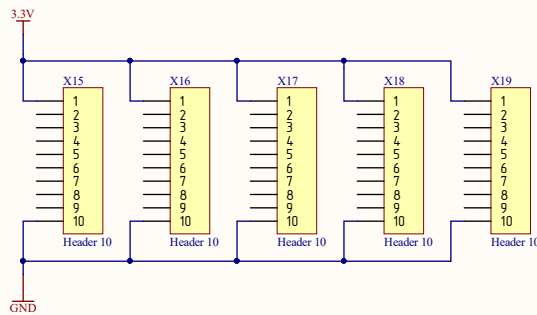
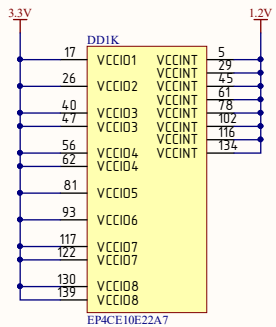
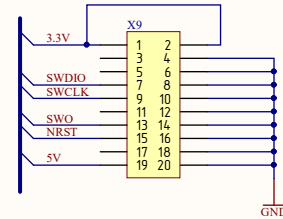
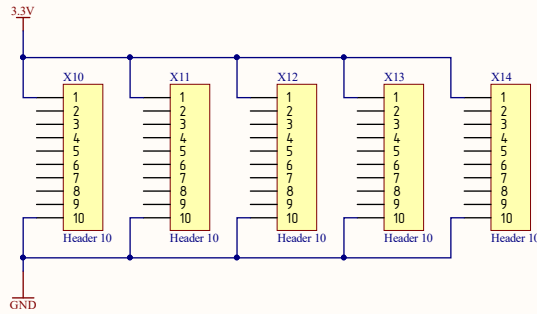
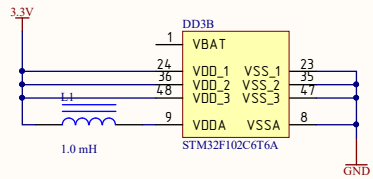
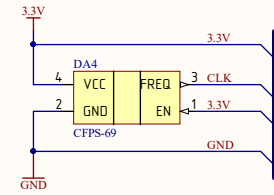
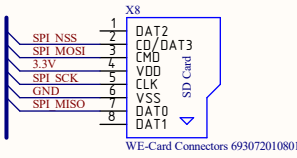
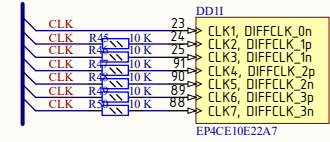
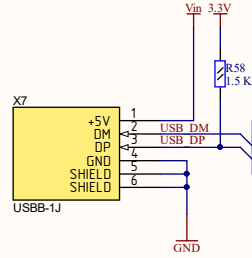
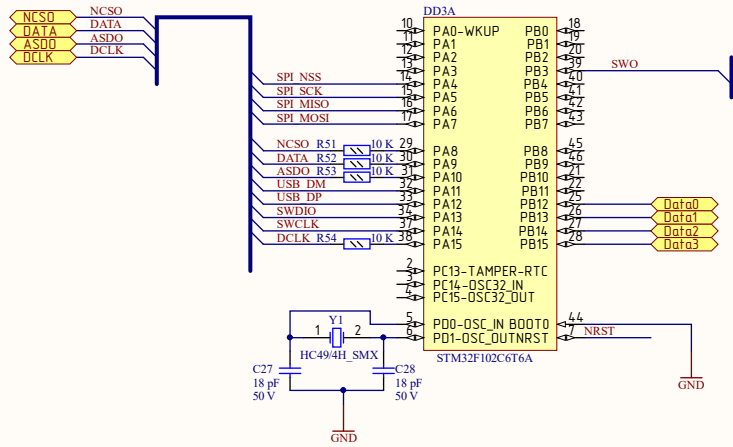

Подн. у дама
Инд. № дубл.
Взаим. инд. №
Подн. у дама
Инд. № подл.

Изм.	Лист	№ докум.	Подн.	Дата
------	------	----------	-------	------

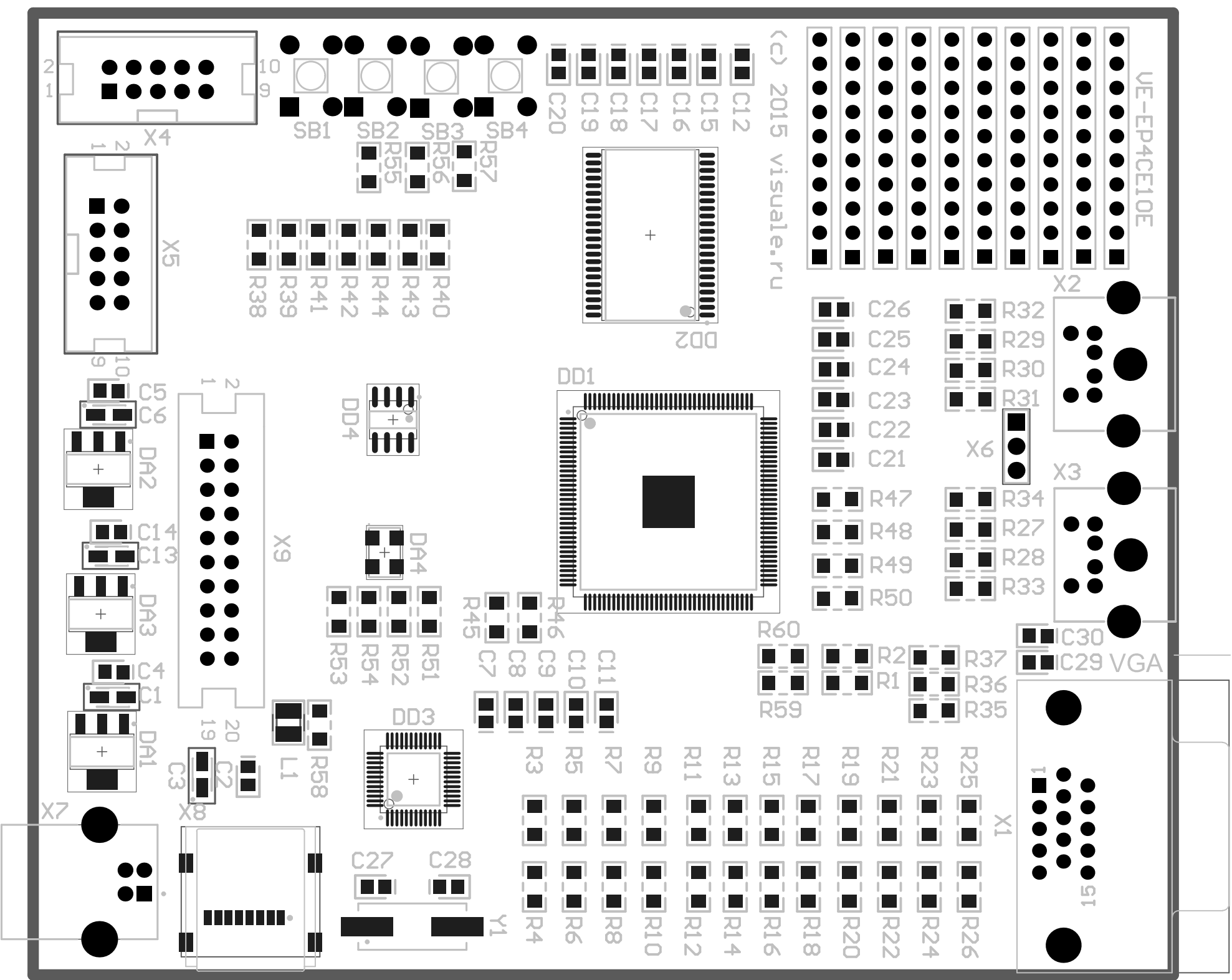

VE-EP4CE10E

(c) 2015 visuelle.ru

X2

X3

X6

X1

51

VGA

C30
C29

R32
R29
R30
R31
R34
R27
R28
R33

C26
C25
C24
C23
C22
C21
R47
R48
R49
R50

R60
R59
R2
R1
R37
R36
R35

C12
C15
C16
C17
C18
C19
C20

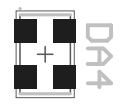
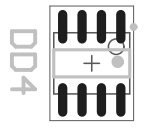
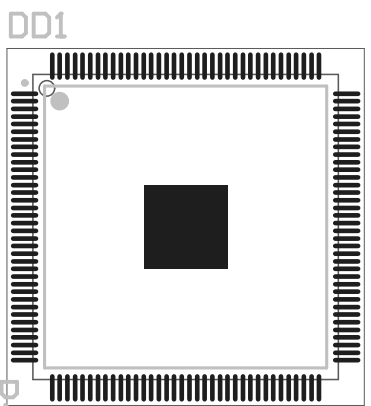
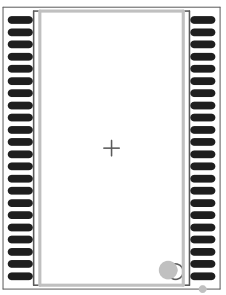

R51
R52
R53
R54
R55

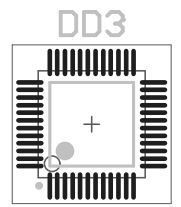

C27
C28
Y1

R40
R43
R44
R42
R41
R39
R38

X9

R58
L1

R6

SB1
SB2
SB3
SB4

R57
R56
R55

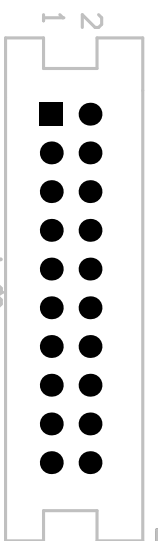

C2
C3

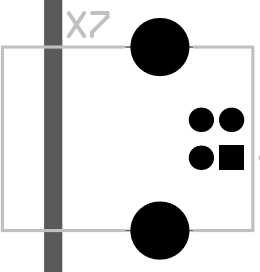
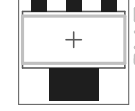
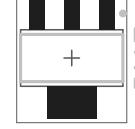
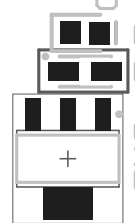
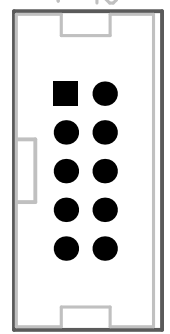
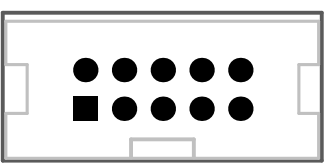
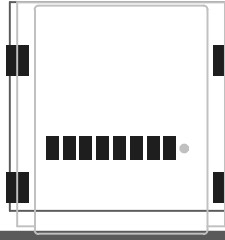

1
2

1
2

9
10

1
2

19
20